

Notice de pose / Directions for use

Profils et accessoires pour hygiène et protection des locaux agro-alimentaires

Hygienic protective
profiles and accessories
for food processing areas

**MAINE
PEILLEX**
—MP—

Congés d'angle / Corner coving angles

Montage / Setting

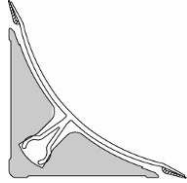

4404 SAN + 4915 EC
4404 SAN + 4915 / 4915 GR
4404 SAN + 4403

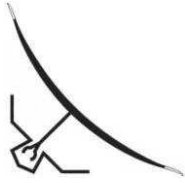

4404 PVC + 4915 / 4915GR
4404 PVC + 4403
4404 PVC + 4915 EC



11909U ALU + 4403
11909U ALU + 4915 EC
11909U ALU + 4915 / 4915 GR

Notice de pose / Directions for use

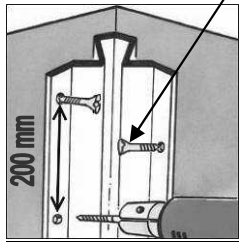
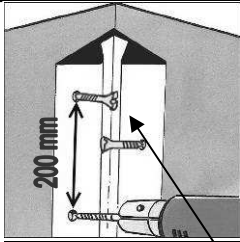

Ø 4,2 mm

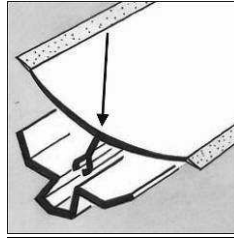
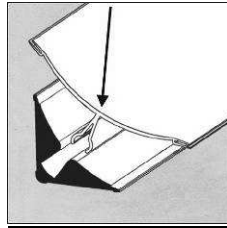

BOSTIK réf. Mastic AG ou équivalent / or similar

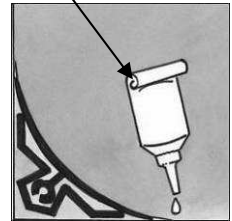
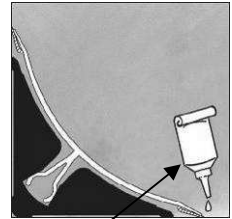

Montage des pièces de finition / Setting of the finishing pieces

J3D
Jonction 3 directions
3 ways junction part

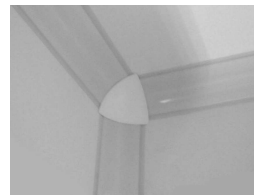

J2D
Jonction 2 directions
2 ways junction part



JS2D
Jonction sortante 2 directions
2 ways convex junction part



U de sol / U for isotherm panel

Croquis des profilés / Drawing of the profiles



U 40 & U 45



U 60 & U 80



U 90 → 120

Notice de pose / Directions for use

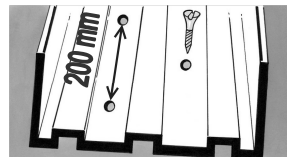

Plinthes / Skirtings

Croquis des profilés / Drawing of the profiles



4232



44068



44182

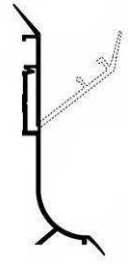

44182PR

Notices de pose / Directions for use

4232

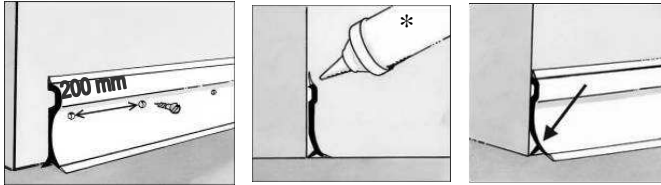

44068

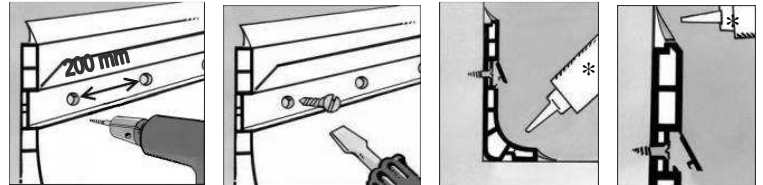

44182

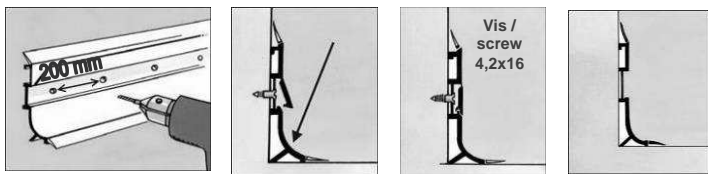

44182PR

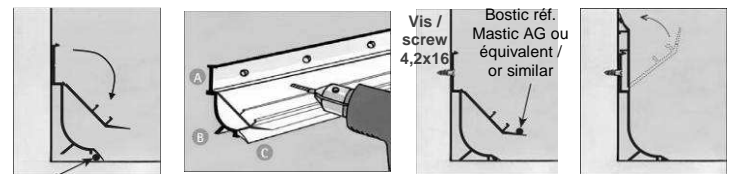

* Bostic Réf. Mastic AG ou équivalent / or similar

Montage des pièces de finition / Setting of the finishing pieces

44068

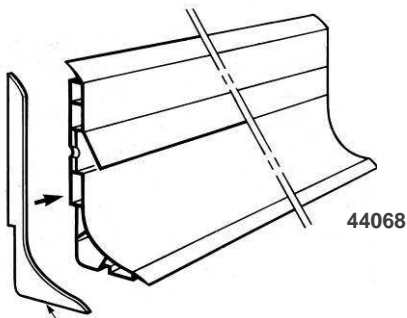

Pièce de finition / End cap

Pièces de finition rigides à fixations mécaniques cachées uniquement

Rigid finishing pieces Mechanical hidden fastenning

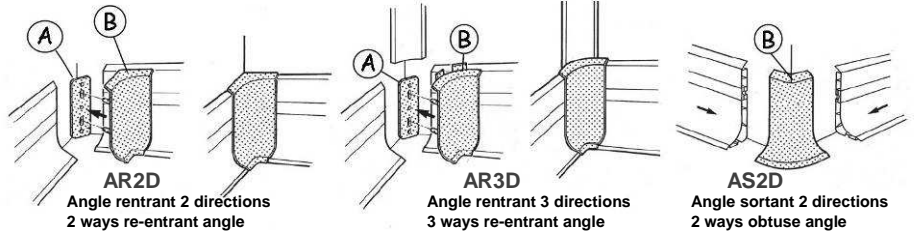

44182 et 44182PR

OU / OR

Pièces de finition souples à fixation mécanique ou à fixation par adhésif

Soft finishing pieces Mechanical or adhesive fastenning

Pièces de finition rigides à fixations mécaniques cachées uniquement

Rigid finishing pieces Mechanical hidden fastenning

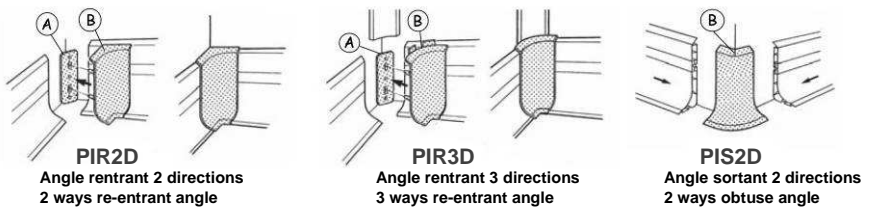
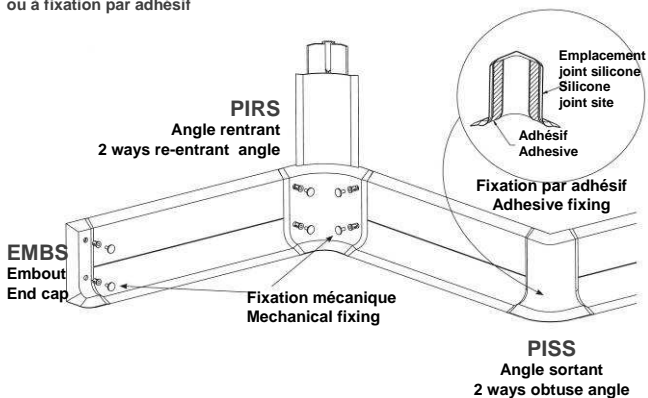

Lisses de protection / Protective coverings

Croquis des profilés / Drawing of the profiles

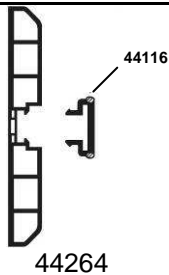

Notice de pose / Directions for use

44264

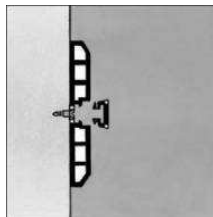
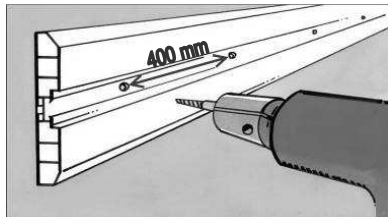

4276

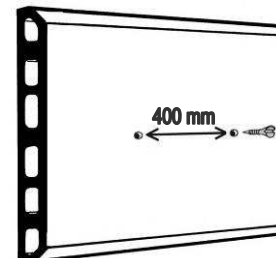
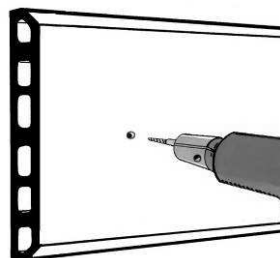

44115

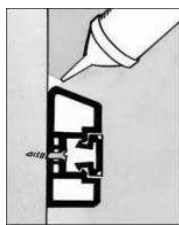
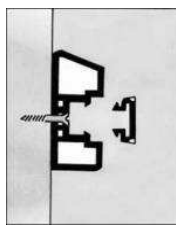
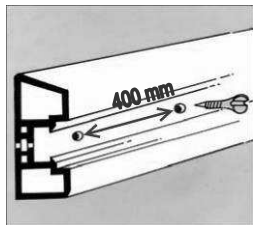

Pièces de finition / Finishing pieces

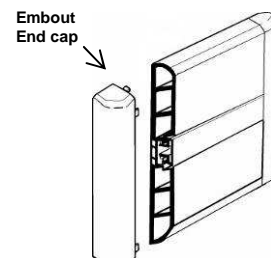
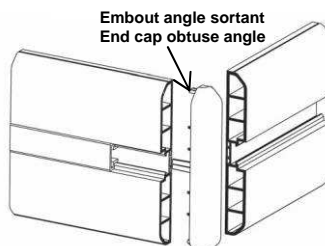
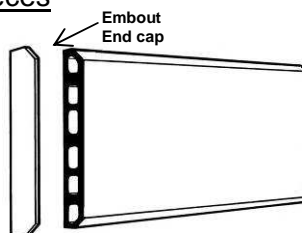
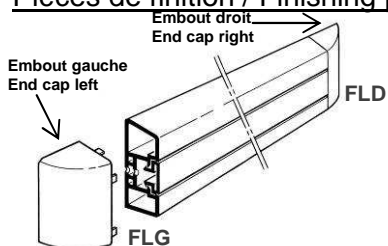

Chevrons de sol / Insulation air-flow supports

Notice de pose / Directions for use

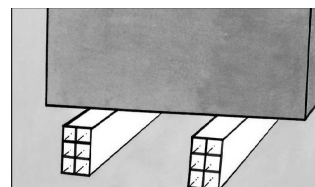
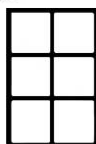
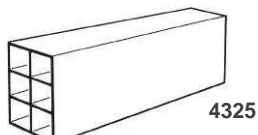
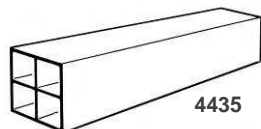

**MAINE
PEILLEX**
— mp —

www.maine-peillex.com